

Note: For safe clear span ratings please contact manufacturer with loading information.

BLADES

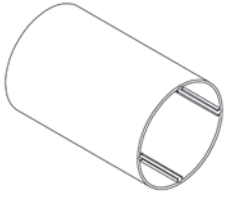

Round

Sizes: 1", 2", 3", 4"
Maximum Length: 12'

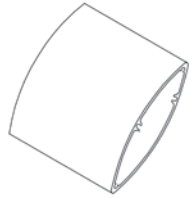

Airfoil

Sizes: 4", 6", 8"
Maximum Length: 12'

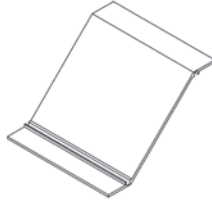

Z-Blade

Sizes: 4", 6"
Maximum Length: 12'

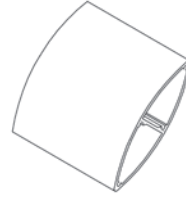

Longspan Airfoil

Sizes: 4", 6", 8"
Maximum Length: 16'

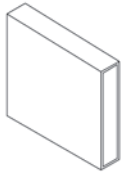

Flat

Sizes: 1/2" x 1" - 4"
Maximum Length: 12'

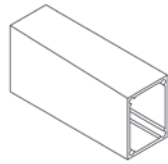

Square

Sizes: 2" - 8"
Maximum Length: 12'



Rectangular

Sizes: 1"-2" x 4"-8"
Maximum Length: 12'

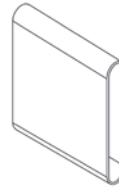

Shutter

Sizes: 1/2" x 1" - 4"
Maximum Length: 12'

Note: Any of the blades shown above can be customized for various spacing or angle requirements.

SCREENS

16 BarScreen

Solar Block up to 66° above horizon. Also available in **I-Bar** and **LiteBarScreen** profiles.

- ▶ up to 4' Width
- ▶ up to 12' Length

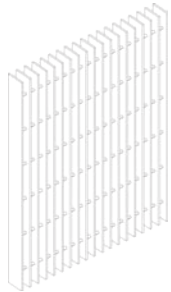

VisiScreen

Solar Block up to 66° above horizon.

- ▶ up to 4' Width
- ▶ up to 12' Length

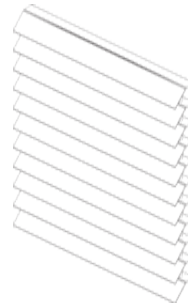

32 BarScreen

Solar Block up to 58° above horizon. Also available in **I-Bar** and **LiteBarScreen** profiles.

- ▶ up to 4' Width
- ▶ up to 12' Length

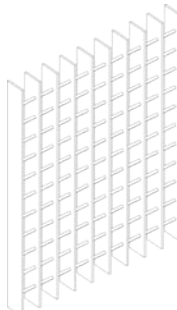

Egg-Crate

Solar Block up to 62° above horizon.

- ▶ up to 4' Width
- ▶ up to 12' Length
- ▶ 1"-12" openings
- ▶ 1"-6" depths

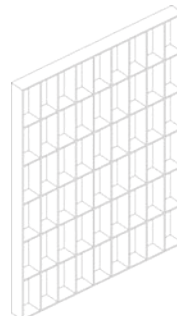

FASCIA

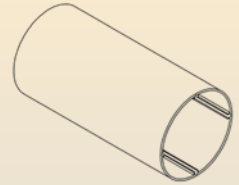

Round Tube

Sizes: 3" - 6"
Maximum Length: 12'

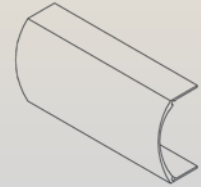

Bullnose

Sizes: 4" & 6"
Maximum Length: 12'

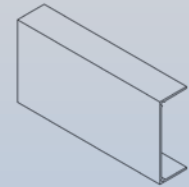

Channel

Sizes: 4" & 6"
Maximum Length: 12'

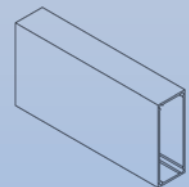

Rectangular Tube

Sizes: 1"-2" x 4"-8"
Maximum Length: 12'

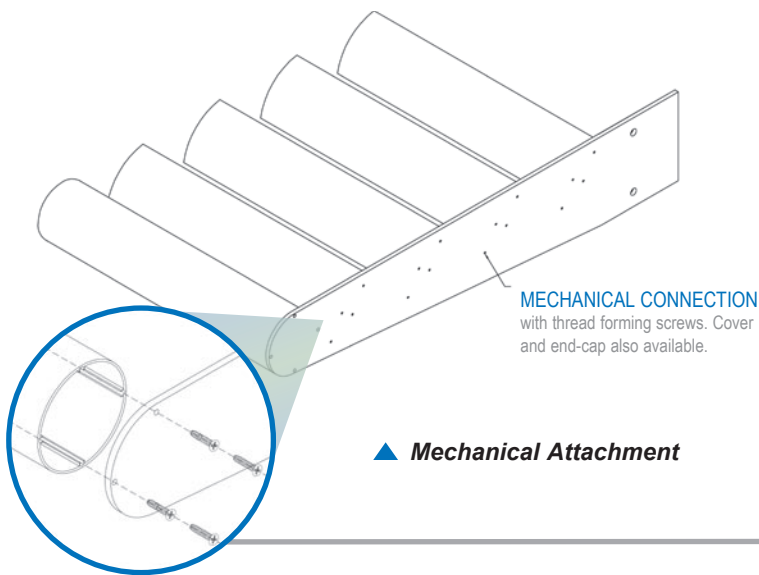

▲ Mechanical Attachment

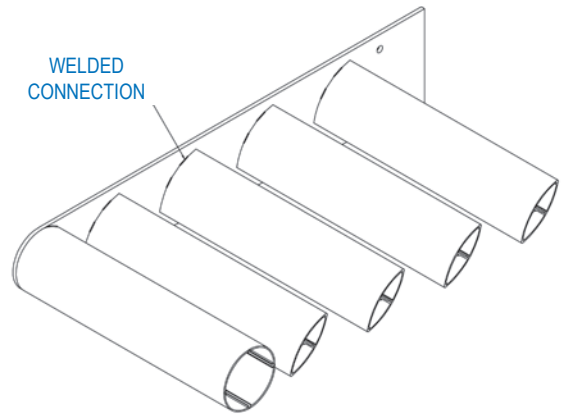

▲ Welded Attachment

OUTRIGGERS

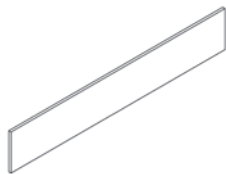

Rectangular Plate

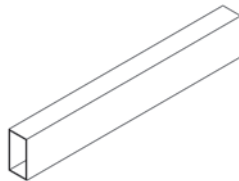

Rectangular Tube

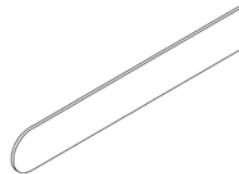

Round Plate

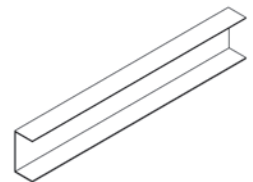

Channel



Tapered Plate



Angular Plate



Half Round Plate

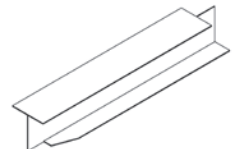

Flat Iron

BRACKETS

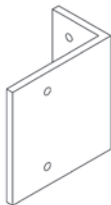

End Line

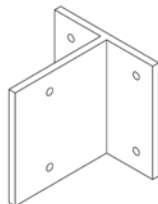

In-Line Wall

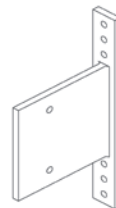

Curtain Wall

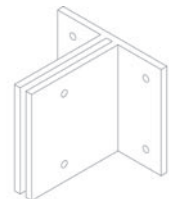

In-Line Sleeve

PERFORATED

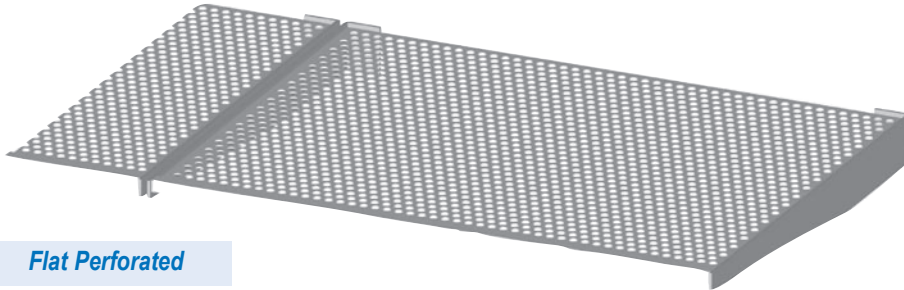

Flat Perforated



Flat Sheet with Integrated Trim ▲

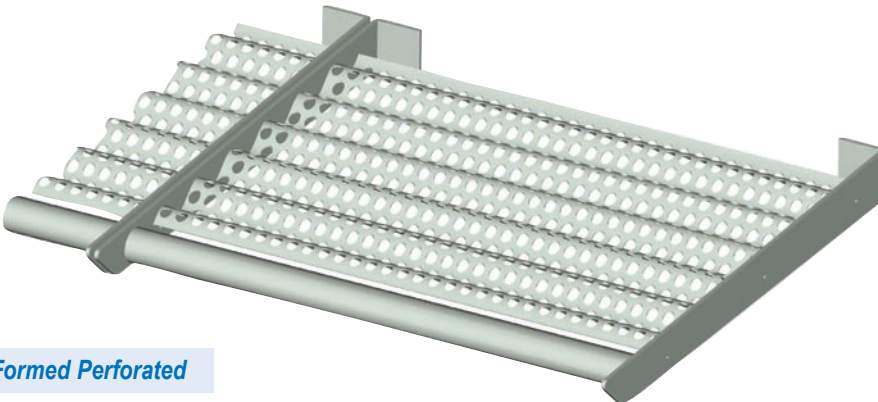

Formed Perforated



Formed Sheet with Mounting Shelf ▲

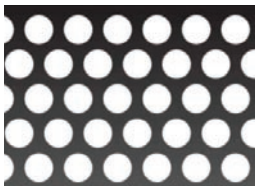

50-1116-RD

- ▶ 1/2" Round
- ▶ 47% Open Area



23-38-RD

- ▶ 1/4" Round
- ▶ 40% Open Area



125-316-RD

- ▶ 1/8" Round
- ▶ 40% Open Area

ANODIZED FINISHES



Clear

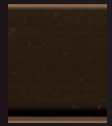

Med. Bronze



Champagne

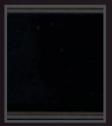

Black

PAINT COLORS



Sage
(RAL 6013)



Green
(RAL 6002)



Blue
(RAL 5007)



Red
(RAL 3016)



Black
(RAL 8022)



Gray
(RAL 7015)



Almond
(RAL 8000)



White
(RAL 9016)

OGi also offers over 300 RAL, Newlar / Kynar / Durnar & powder paints. Contact OGi for additional information.